

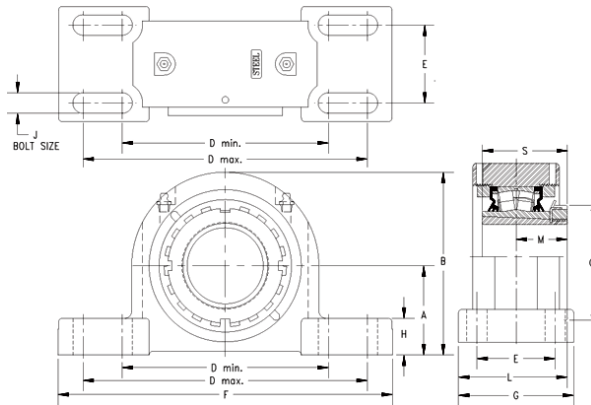

HMSA BEARING MANUFACTURING LIMITED



timken DVPF17K075S Solid Block/Spherical Roller Bearing Housed Units-Tapered Adapter Four-Bolt Pillow Block

Bearing No. DVPF17K075S

DVPF17K075S Bearing 2D drawings and 3D CAD models

Engineering Group	Mounted Bearing
Shaft Size	75 mm
Shaft Size Type	Metric
Full Timken Part Number	DVPF17K075SB
Locking Style	Tapered Adapter
Weight	51 lb
Housing Style	Four-Bolt Pillow Block
UPC Code	0883450010429
Dimension A	3.25 in
Dimension B	6.79 in
Dimension C	4.33 in
Dimension D Max	9.10 in
Dimension D Min	7.60 in
Dimension E	1.88 in
Dimension F	10.44 in
Dimension G	3.130 in
Dimension H	1.29 in
Dimension J (Bolt Size)	0.625 in
Dimension L	3.41 in
Dimension M	1.96 in
Dimension S	3.23 in
C0 - Static Load	71900 lb
C - Dynamic Load (Basic)	66900 lb
e - Geometry Factor	0.22
Y1 - Geometry Factor	3.07



HMSA BEARING MANUFACTURING LIMITED

Y2 - Geometry Factor	4.57
Oil Lubrication - M/N Seal	1400 rpm
Oil Lubrication - T Seal	2400 rpm
Oil Lubrication - B/C/O Seal	1100 rpm
Grease Lubrication - M/N Seal	1400 rpm
Grease Lubrication - T Seal	2000 rpm
Grease Lubrication - B/C/O Seal	1100 rpm
Float	0.083 in
Shaft Tolerance	0.0040 in
Pre Install Clearance Min	0.0043 in
Pre Install Clearance Max	0.0055 in
Int Radial Clearance Reduction Min	0.0018 in
Int Radial Clearance Reduction Max	0.0025 in
Adapter Sleeve Axial Movement Min	0.027 in
Adapter Sleeve Axial Movement Max	0.038 in
Post Install Int Radial Clearance Min	0.0020 in