

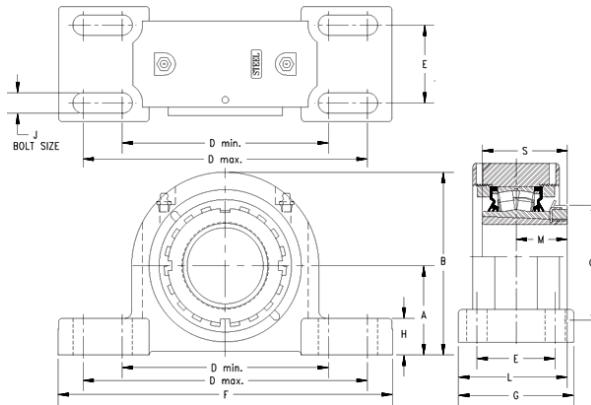

HMSA BEARING MANUFACTURING LIMITED



timken DVPF20K308S Solid Block/Spherical Roller Bearing Housed Units-Tapered Adapter Four-Bolt Pillow Block

Bearing No. DVPF20K308S

DVPF20K308S Bearing 2D drawings and 3D CAD models

Engineering Group	Mounted Bearing
Shaft Size	3-1/2 in
Shaft Size Type	Imperial
Full Timken Part Number	DVPF20K308SB
Locking Style	Tapered Adapter
Weight	70.0 lb
Housing Style	Four-Bolt Pillow Block
UPC Code	0883450010924
Dimension A	3.75 in
Dimension B	7.88 in
Dimension C	5.12 in
Dimension D Max	10.88 in
Dimension D Min	8.88 in
Dimension E	2.00 in
Dimension F	12.30 in
Dimension G	3.7500 in
Dimension H	1.56 in
Dimension J (Bolt Size)	0.750 in
Dimension L	3.99 in
Dimension M	2.3 in
Dimension S	3.82 in
C0 - Static Load	113000 lb
C - Dynamic Load (Basic)	97700 lb
e - Geometry Factor	0.24
Y1 - Geometry Factor	2.85



HMSA BEARING MANUFACTURING LIMITED

Y2 - Geometry Factor	4.24
Oil Lubrication - M/N Seal	1200 rpm
Oil Lubrication - T Seal	2000 rpm
Oil Lubrication - B/C/O Seal	900 rpm
Grease Lubrication - M/N Seal	1200 rpm
Grease Lubrication - T Seal	1600 rpm
Grease Lubrication - B/C/O Seal	900 rpm
Float	0.083 in
Shaft Tolerance	0.0040 in
Pre Install Clearance Min	0.0043 in
Pre Install Clearance Max	0.0055 in
Int Radial Clearance Reduction Min	0.0018 in
Int Radial Clearance Reduction Max	0.0025 in
Adapter Sleeve Axial Movement Min	0.027 in
Adapter Sleeve Axial Movement Max	0.038 in
Post Install Int Radial Clearance Min	0.0020 in