

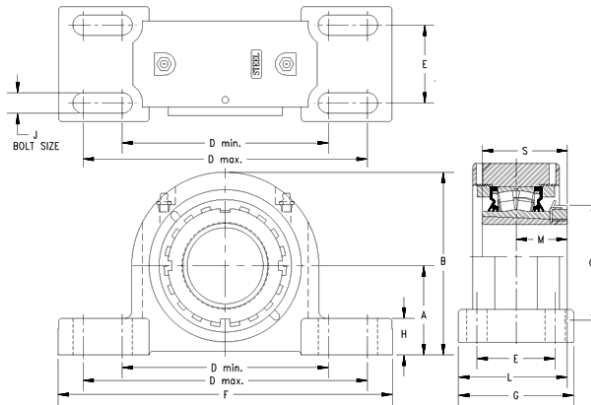

HMSA BEARING MANUFACTURING LIMITED



timken DVPF22K400S Solid Block/Spherical Roller Bearing Housed Units-Tapered Adapter Four-Bolt Pillow Block

Bearing No. DVPF22K400S

DVPF22K400S Bearing 2D drawings and 3D CAD models

Engineering Group	Mounted Bearing
Shaft Size	4 in
Shaft Size Type	Imperial
Full Timken Part Number	DVPF22K400SB
Locking Style	Tapered Adapter
Weight	85 lb
Housing Style	Four-Bolt Pillow Block
UPC Code	0883450011228
Dimension A	4.25 in
Dimension B	8.780 in
Dimension C	5.71 in
Dimension D Max	13.38 in
Dimension D Min	10.88 in
Dimension E	2.25 in
Dimension F	14.88 in
Dimension G	4.310 in
Dimension H	1.40 in
Dimension J (Bolt Size)	0.750 in
Dimension L	4.36 in
Dimension M	2.48 in
Dimension S	4.13 in
C0 - Static Load	147000 lb
C - Dynamic Load (Basic)	125000 lb
e - Geometry Factor	0.25
Y1 - Geometry Factor	2.73



HMSA BEARING MANUFACTURING LIMITED

Y2 - Geometry Factor	4.06
Oil Lubrication - M/N Seal	900 rpm
Oil Lubrication - T Seal	1700 rpm
Oil Lubrication - B/C/O Seal	600 rpm
Grease Lubrication - M/N Seal	900 rpm
Grease Lubrication - T Seal	1200 rpm
Grease Lubrication - B/C/O Seal	600 rpm
Float	0.083 in
Shaft Tolerance	0.0040 in
Pre Install Clearance Min	0.0053 in
Pre Install Clearance Max	0.0067 in
Int Radial Clearance Reduction Min	0.0020 in
Int Radial Clearance Reduction Max	0.0028 in
Adapter Sleeve Axial Movement Min	0.03 in
Adapter Sleeve Axial Movement Max	0.042 in
Post Install Int Radial Clearance Min	0.0025 in