

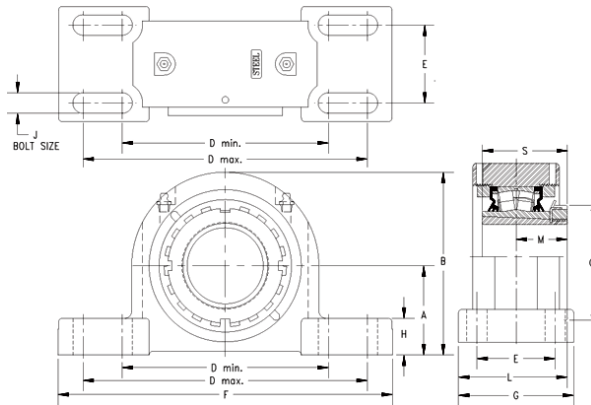

HMSA BEARING MANUFACTURING LIMITED



timken DVPF26K408S Solid Block/Spherical Roller Bearing Housed Units-Tapered Adapter Four-Bolt Pillow Block

Bearing No. DVPF26K408S

DVPF26K408S Bearing 2D drawings and 3D CAD models

Engineering Group	Mounted Bearing
Shaft Size	4-1/2 in
Shaft Size Type	Imperial
Full Timken Part Number	DVPF26K408SB
Locking Style	Tapered Adapter
Weight	137.0 lb
Housing Style	Four-Bolt Pillow Block
UPC Code	0883450011426
Dimension A	4.75 in
Dimension B	9.87 in
Dimension C	6.50 in
Dimension D Max	14.50 in
Dimension D Min	11.90 in
Dimension E	2.50 in
Dimension F	16.13 in
Dimension G	4.7500 in
Dimension H	1.58 in
Dimension J (Bolt Size)	0.750 in
Dimension L	4.87 in
Dimension M	2.83 in
Dimension S	4.730 in
C0 - Static Load	212000 lb
C - Dynamic Load (Basic)	170000 lb
e - Geometry Factor	0.26
Y1 - Geometry Factor	2.62



HMSA BEARING MANUFACTURING LIMITED

Y2 - Geometry Factor	3.90
Oil Lubrication - M/N Seal	700 rpm
Oil Lubrication - T Seal	1500 rpm
Oil Lubrication - B/C/O Seal	400 rpm
Grease Lubrication - M/N Seal	700 rpm
Grease Lubrication - T Seal	1000 rpm
Grease Lubrication - B/C/O Seal	400 rpm
Float	0.083 in
Shaft Tolerance	0.0040 in
Pre Install Clearance Min	0.0063 in
Pre Install Clearance Max	0.0079 in
Int Radial Clearance Reduction Min	0.0025 in
Int Radial Clearance Reduction Max	0.0035 in
Adapter Sleeve Axial Movement Min	0.035 in
Adapter Sleeve Axial Movement Max	0.050 in
Post Install Int Radial Clearance Min	0.0030 in